



[www.all.s.ee](http://www.all.s.ee)





# Elxis

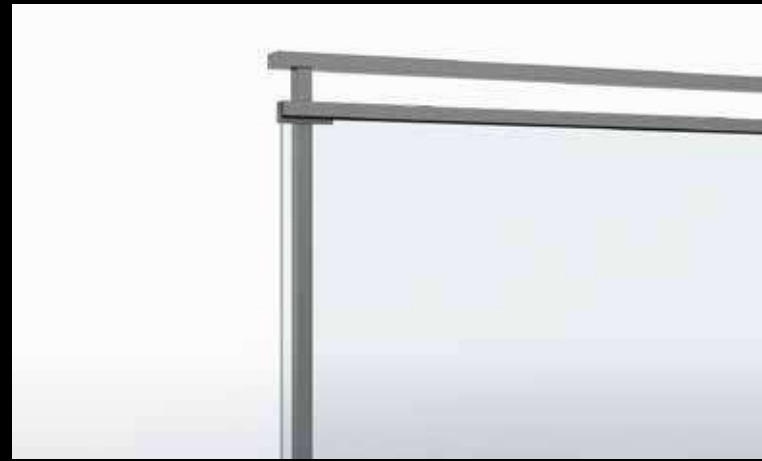

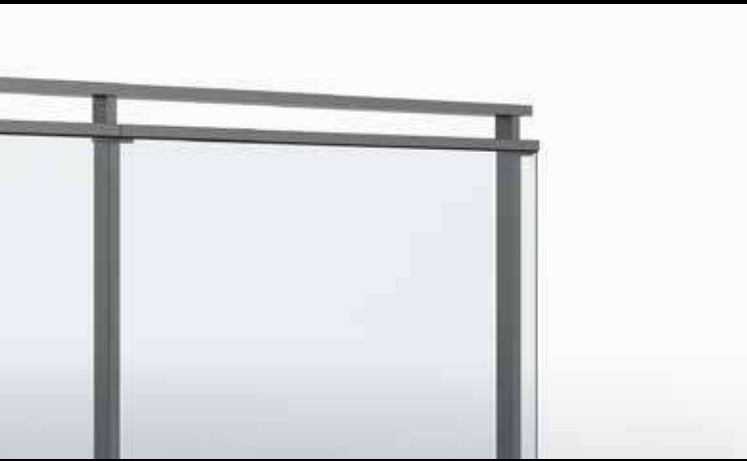

- # Modern design that highlights the simplicity of design lines, ideal for minimal design spaces.
- # High levels of robustness for large window openings.
- # Column width for only 28 mm.
- # Maximum width between the columns 1300 mm.
- # Minimum components, offering economy and ergonomics.
- # Having no visible screws for perfect aesthetic result.
- # Glass application at the bottom rail having handrail at the top.
- # Handrail choices in numerous shapes satisfying the most demanding needs.
- # Available in all electrostatic and anodising shades.
- # Ideal solution for indoor and outdoor spaces, balcony areas, fences, interior and exterior stairs.
- # Maximum glass thickness 55.4PVB=11.52 mm





**Elxis**

# Rail assembly typical steps:

1. Assemble post & footplate
2. Fix assembled post onto the ground
3. Screw glass holder (detail f) onto post on the upper part & lower part of the post
4. Mount assembled glass panel onto post glass holder
5. Screw fix rectangular handrail onto post, to connect posts in the line
6. Finally, click & connect the top handrail part onto the rectangular handrail to fulfill the rail assembly

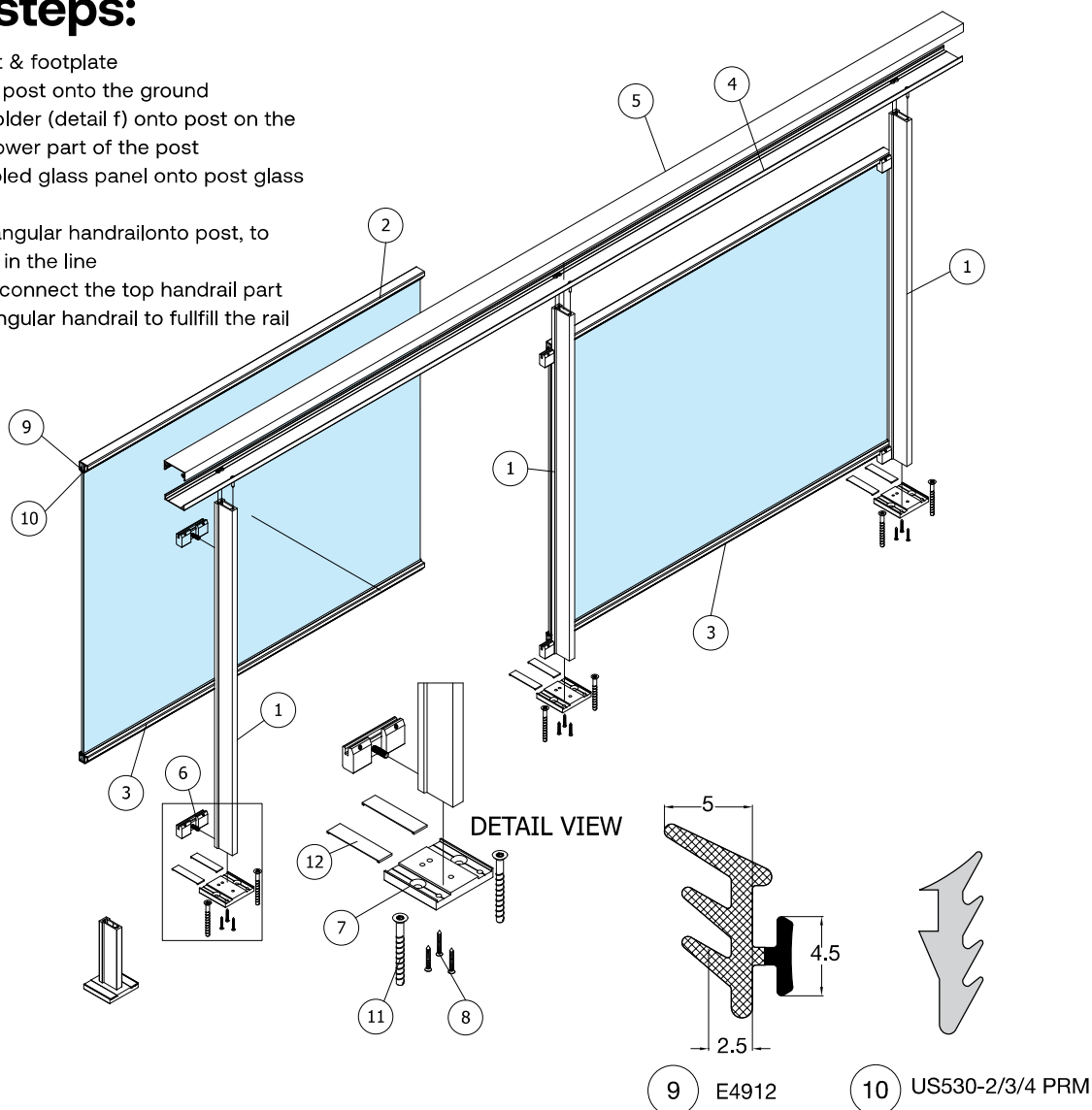

Item	Qty	Part Number	Description
1	3	FSN-101	Elxis post
2	2	FSN-301	Glass guide rail
3	2	FSN-300	Glass guide rail
4	1	CLS-201	Handrail base
5	1	FSN-221	Handrail cover
6	6	4753	Glass holder
7	3	4711	Elxis footplate
8	9	DIN7982-6.3x50	Footplate screws
9	2	E4912	Gasket
10	2	US530-2/3/4 PRM	Glazing gasket
11	2	EBM-10120G/2	Fischer concrete screw
12	2	E4710	Footplate cover

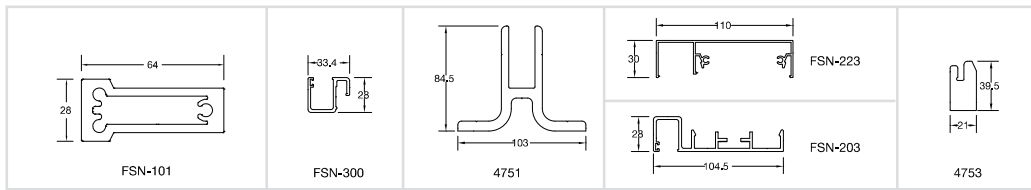
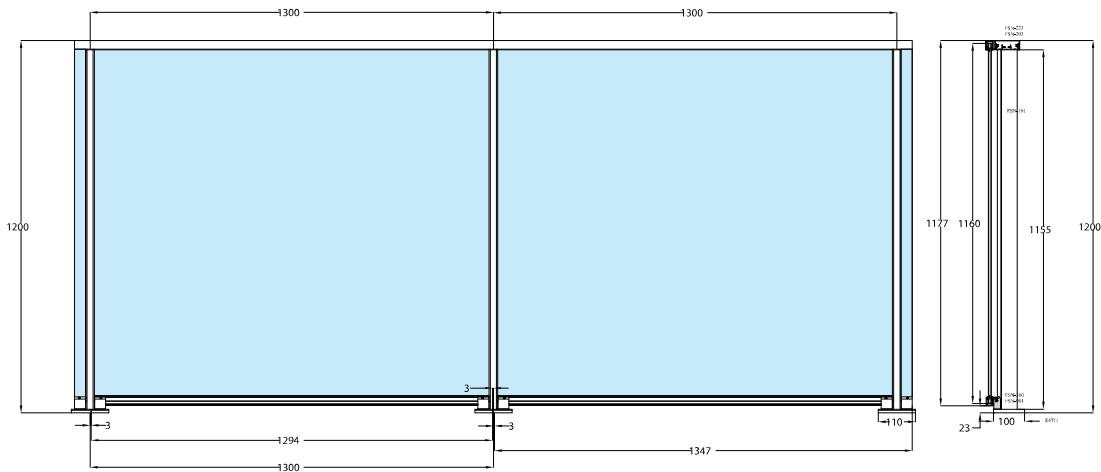
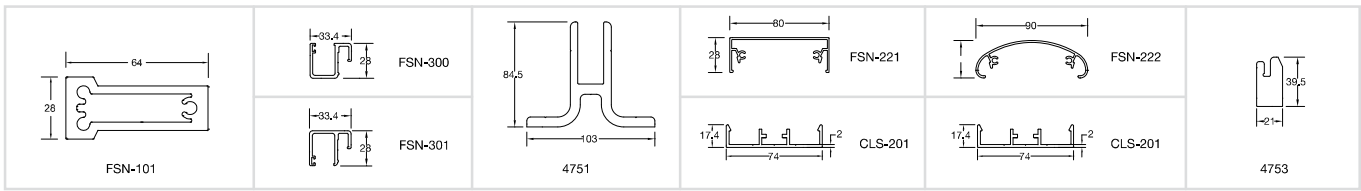
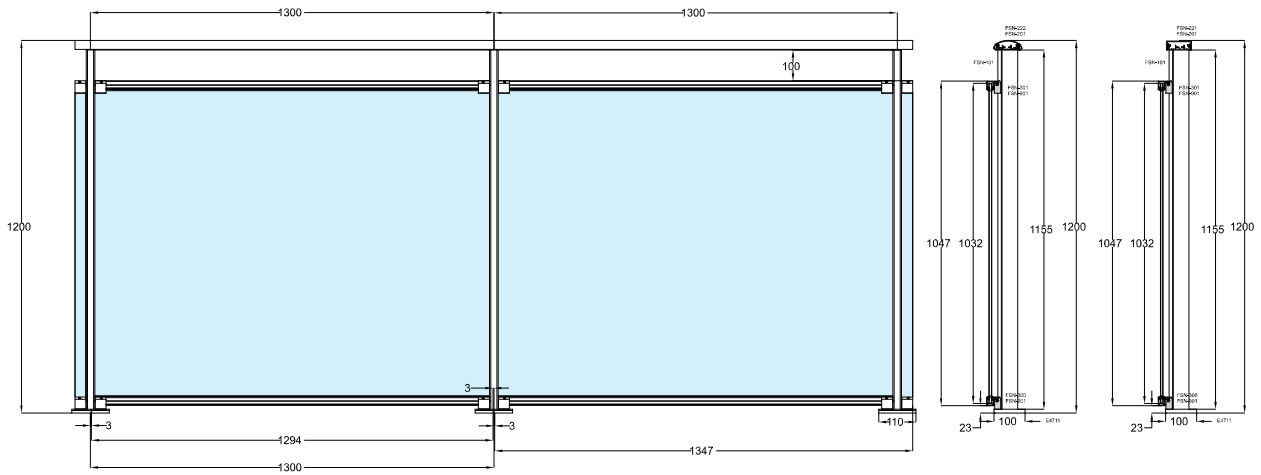

**GENERAL EXAMPLE  
OF EXTERNAL FIXING  
FUSION ELXIS E4755-HD**

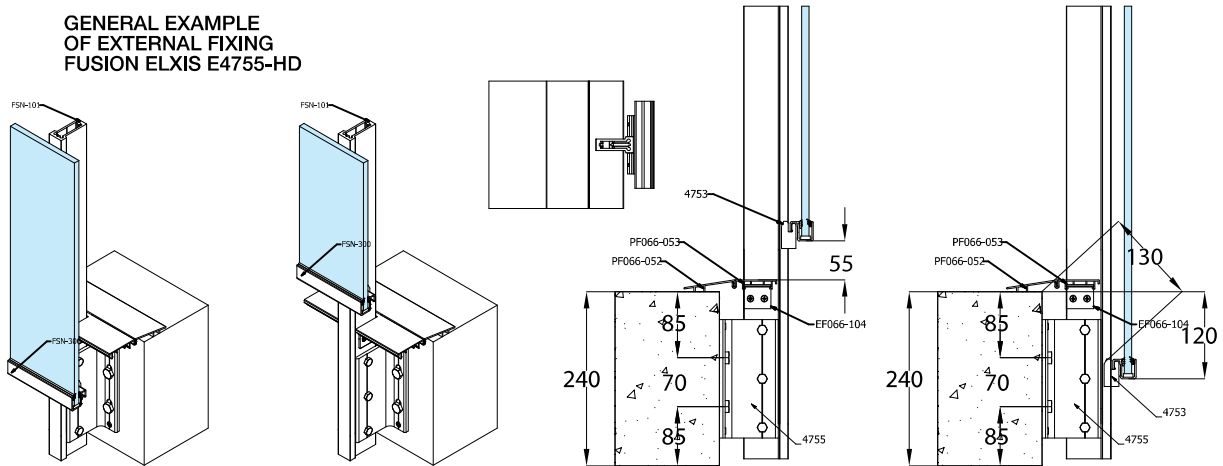

**Assembly Elxis**

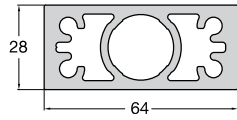

Code: **FSN-105**

COLUMN 28x64

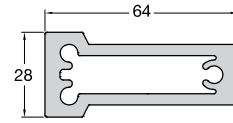

Code: **FSN-101**

COLUMN 28x64

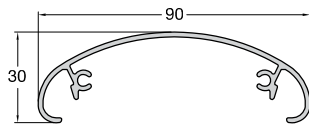

Code: **FSN-222**

COVER FOR HANDRAIL 90X30

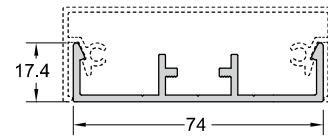

Code: **CLS-201**

BASE FOR HANDRAIL FSN-221/222

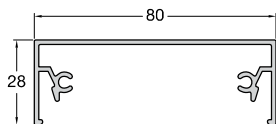

Code: **FSN-221**

COVER FOR HANDRAIL 80X28

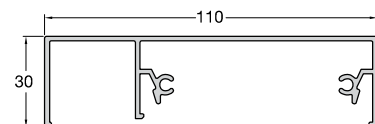

Code: **FSN-223**

COVER FOR HANDRAIL 110x30

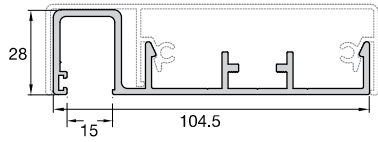

Code: **FSN-203**

BASE FOR HANDRAIL FSN-223

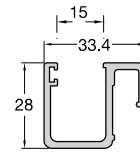

Code: **FSN-300**

GUIDE FOR GLASS (DOWN)

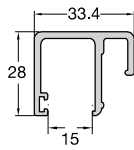

Code: **FSN-301**

GUIDE FOR GLASS (UP)



Code: **4167**

INFLOOR SUPPORT FOR COLUMN FSN-105



Code: **4289**

CORNER CONNECTOR 90° FOR HANDRAIL CLS-201



Code: **4275**  
HANDRAIL CONNECTOR



Code: **4711**

SUPPORT FOOT FOR COLUMN FSN-101



Code: **4731**

SUPPORT FOOT FOR COLUMN FSN-105



Code: **4717**

SUPPORT FOOT FOR COLUMN FSN-105



Code: **4737**

SUPPORT FOOT FOR COLUMN FSN-105



Code: **4923**

END CAP FOR HANDRAIL FSN-223



Code: **US530-2/3/4 PRM**

GLAZING GASKET



Code: **4912**

GLAZING GASKET



Code: **4938**

END CAP FOR COLUMN FSN-101



Code: **EA410-420M**

GLAZING GASKET



Code: **4751**

WALL SUPPORT FOR COLUMN FSN-101



Code: **4755**

WALL SUPPORT FOR COLUMN FSN-101 (HEAVY DUTY)



Code: **4753 / 4758**

GLASS SUPPORT FOR COLUMN FSN-101



Code: **4270**

CONNECTOR FOR CLS-201/301/302/305



Code: **4921**

END CAP FOR HANDRAIL FSN-222



Code: **4922**

END CAP FOR HANDRAIL FSN-221